

Super Silent Blowers

**E2271Z**

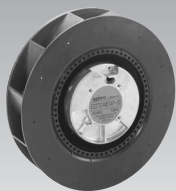

$\phi 220 \times 71$  ( $\phi 8.7" \times 2.8"$ )  
Max. airflow: 18.1 m<sup>3</sup>/min  
Max. static pressure: 650 Pa  
Mass: 1300 g

**Features**

- Large airflow, high static pressure backward blowers without housing.
- A low noise effect can be achieved by combining an inlet ring.

Fan model code

**E2271Z24B5YP-00**

**E2271Z48B7AP-00**

**Standard specification**

Max. Airflow		Max. Static Pressure		Noise	Speed	Voltage Spec. V		Current mA		Model Code	Operating Temp. Range °C
m <sup>3</sup> /min	CFM	Pa	inH <sub>2</sub> O	dB	min <sup>-1</sup>	Rating	Operating Range	Rating	Starting		
18.1	639	600	2.61	74	3200	48	36-57	2100	3800	<b>E2271Z48B7AP-00</b>	-20 ~ +60
14.7	519	470	1.89	66	2650	24	21.6-26.4	2600	3800	<b>E2271Z24B5YP-00</b>	-20 ~ +40

- Figures in the table are average measured values. Please request the product delivery specification when preparing a purchase specification.
- The characteristics are the values at rated voltage (24V, or 48 V), and normal temperature and humidity.
- This product has limitations to ON/OFF functionality. For details, please reference the relevant diagrams in the specification.

**General specification**

Materials Used	Ventur: Aluminum alloy die castings Impeller: ABS and PBT synthetic resins Bearing: Both side shielded ball bearing
Motor	Brushless DC motor, Protection type: Overcurrent detection and automatic resetting by current limiting
Common Elec. Spec.	See pages G-11, G-12, G-13.

**Standard airflow and static pressure characteristics (At rated voltage)**

[By double chamber method]  
(Performance when an inlet ring is combined)

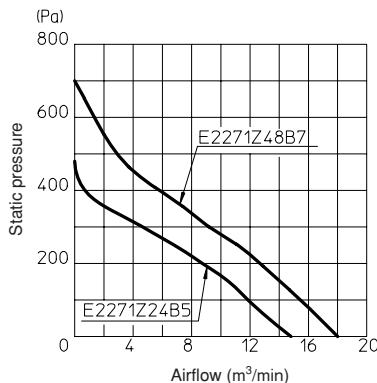

**Wiring connection diagram**

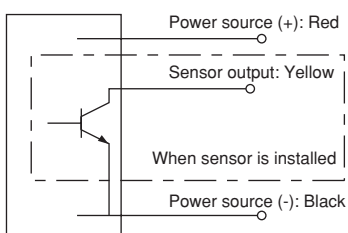

**External dimensions in mm (inches)**

• Lead wire type

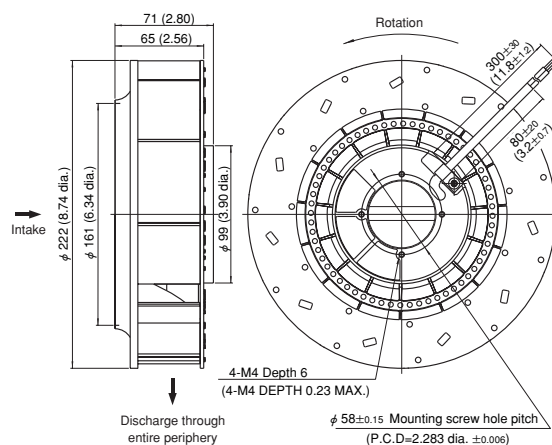

Lead wire spec. AWG24 UL3266  
Color (+) Red  
(-) Black  
(sensor) Yellow

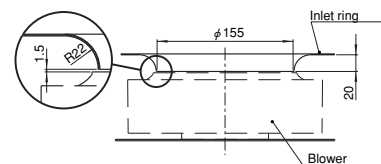

**Options (sold separately)**

- E2271 inlet ring

Products for variable-speed operation by PWM, voltage or resistance value commands can also be supplied with this model. (See pages G-51 and 52.)  
Contact us for further information.

**Super silent blower with sensor**

Rated Vol.	Model Code
24 V	<b>E2271Z24B5YP-00</b>
48 V	<b>E2271Z48B7AP-00</b>

- This product features a large airflow and high static pressure without using a housing. A standard specification is ensured if installed complying with the foregoing bell mouth shape and its position.
- See page G-73 for detailed dimensions of the intake bell mouth.
- A bell mouth fitting accessory (product code E2271 Inlet Ring) is available as an option. (See page G-65.)
- Our company can meet many of your requirements for customization, such as special connectors, other sensors not listed above, variable speed specifications, and other modifications. Please contact us during your product planning and development stage.
- The listed products are registered in the following overseas standards files, UL/cUL: E48889, TUV: R50004410 (E2271Z48B7 only models.)

Fan model code
D0925C12B8ZP-00
D0925C24B8ZP-00
D1225C12BBZP-00
D1225C24BBZP-00
<del>D1238B48B7ZP-00</del>
D1751M48B6ZP-00
<del>D1751M24B5ZP-00</del>
D1751S24B9ZP300
D1751S24B6ZP-00
G0938B48B9ZP-00
G0938B12B8ZP-00
G1238B12BBZP-00
G1238B24BBZP-00
G1238B48BBZP-00
G1238B24BAZP-00
G1751M24B9ZP300
G1751M48B9ZP-00

Blowers
E1033L12BFZP-00
E1033L12BEZP-00
E1033H24BAZP-00
E2271Z48B7ZP-00

## Lineup of PWM variable-speed semi-standard products

- A PWM signal from the customer equipment is input to the control line (blue) of the fan motor for variable-speed operation of fans and blowers. (Input and noise can be reduced when the internal temperature of the customer equipment is low, such as during idling.)
- Sizes  
Axial fans: □92 mm~□172 mm  
Blower: □97 mm~φ220 mm

## Characteristics for reference (The characteristics are typical characteristics and their curves will differ, depending on the particular model)

- Standard values for PWM control signal - speed specification (at rated voltage, open, and normal temperature and humidity)

I <sub>out</sub>	1 mA MAX.
V <sub>out</sub>	5 V MAX.
V <sub>LOsat</sub>	0.4 MAX.
Freq.	500 Hz~5000 Hz

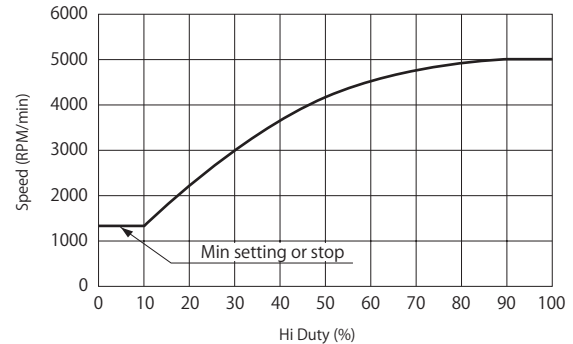
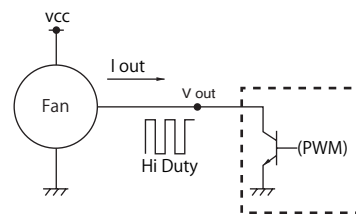

## Semi-standard products (Products in regular production)

Size	Model Code	Max. Airflow		Max. Static Pressure		Noise	Speed min <sup>-1</sup>		Voltage Spec. V		Operating Temp. Range °C
		m <sup>3</sup> /min	CFM	Pa	in.H <sub>2</sub> O		Max.	Min.	Rating	Operating Range	
□92×25mm	D0925C12B8ZP-00	2	71	67	0.27	40	4450	1000	12	10.2-13.2	-20 ~ 60°C
	D0925C24B8ZP-00						4450	1750	24	21.6-26.4	
□120×25mm	D1225C12BBZP-00	4.25	150.1	150	0.6	50.5	5400	1000	12	10.2-13.8	-20 ~ 60°C
	D1225C24BBZP-00								24	20.4-27.6	
□119×38mm	<del>D1238B48B7ZP-00</del>	4.4	155	170	0.68	54	4000	1250	48	40.8-55.2	-20 ~ 70°C
φ172×150×51mm	D1751M48B6ZP-00	10.2	360	315	1.27	64	4800	1000	48	36-60	-20 ~ 70°C
	<del>D1751M24B5ZP-00</del>	9	318	260	1.04	61	4200	1000	24	12-27.6	
φ172×51mm	D1751S24B9ZP300	14.2	501	640	2.57	68	6800	3200	24	16-28	-20 ~ 60°C
	D1751S24B6ZP-00	10.2	360	335	1.35	59	4800	1000	24	12-27.6	
□92×38mm	G0938B48B9ZP-00	3.6	127	440	1.77	61	7000	2000	48	36-55.2	-20 ~ 60°C
	G0938B12B8ZP-00	3.2	113	350	1.41	58	6300	1600	12	8.4-13.8	
□119×38mm	G1238B12BBZP-00	7.4	261	520	2.09	67	6300	1000	12	9.6-13.8	-20 ~ 60°C
	G1238B24BBZP-00								24	16.8-27.6	
	G1238B48BBZP-00								48	36-55.2	
	G1238B24BAZP-00								24	16.8-27.6	
φ172×150×51mm	G1751M24B9ZP300	11.2	395	780	3.13	74	6800	3200	24	16-28	-20 ~ 70°C
	G1751M48B9ZP-00								48	36-60	
97×95×33mm	E1033L12BFZP-00	1.55	55	1400	5.63	66	6900	1800	12	10.8-12.6	-20 ~ 70°C
	E1033L12BEZP-00	1.45	51	1200	4.82	64	6400	1600	12	10.8-13.2	
	E1033H24BAZP-00	1.14	40	500	2.01	58	4850	1800	24	16-26.4	
φ220×71mm	E2271Z48B7ZP-00	18.1	639	600	2.41	74	3200	1000	48	36-57	-20 ~ 60°C

- Aside from the above models, please see also the high pressure, variable speed G series fans. Details may be found in specs G-31 to G-36.
- The lineup of variable-speed fans and blowers will be expanded regularly. Visit the Website for information on the latest lineup.
- Direct your inquiry to our company for connector termination to lead wires, for sensor specifications other than those contained in the catalog and for variable speed specifications. (Products tailored to voltage command control and resistance value command control are also available)
- To ensure correct installation and smooth operation please obtain a drawing for approval or reference drawing from us.

\* For red-lines product, Discontinued.

Filter

3-piece set

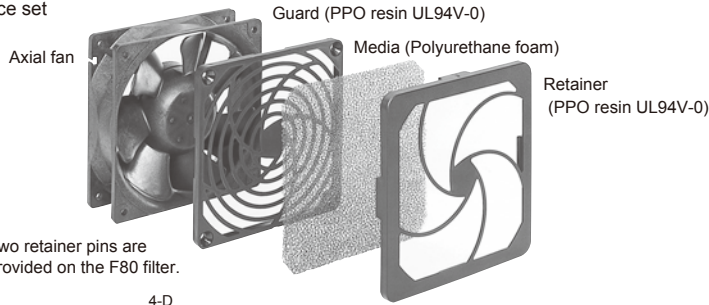

Note: Two retainer pins are provided on the F80 filter.

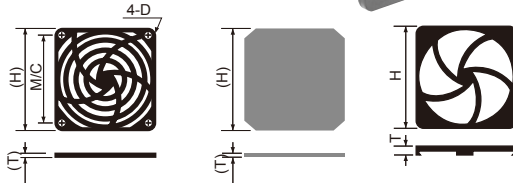

List of mating fan series

Filter	F80	F92	F120
PUDC	○		
D0925C		○	
KLDC		○	
D1225C			○
CNDC			○
D1238B			○
G0838C	○		
G0938B		○	
G1238B			○

Filter	F80	F92	F120
VE	○		
WE		○	
KA		○	
CU			○
CN			○

Component (Model Code)	H	T	M/C	D
<b>F80 Filter</b>	83.5	10	71.4	φ 4.5
<b>F92 Filter</b>	96.5	11	82.6	φ 3.8
<b>F120 Filter</b>	123.7	11	104.8	φ 4.4

Flange spacer

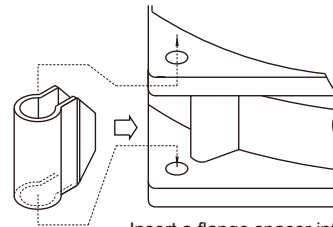
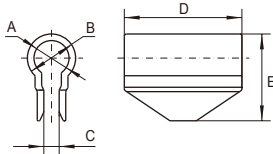

Insert a flange spacer into the ribs of a venturi.

(Installing a flange spacer)

Component (Model Code)	A mm	B mm	C mm	D mm	E mm	Mating Model Code
<b>Flange Spacer PUDC</b> (※)	5	8	2	17	14.5	KUDC,PUDC
<b>Flange SpacerCNDC</b>	8	11	3.5	28	19.8	CNDC

※Ribbed venturis (PUDC-R) are available for PUDC

Inlet ring

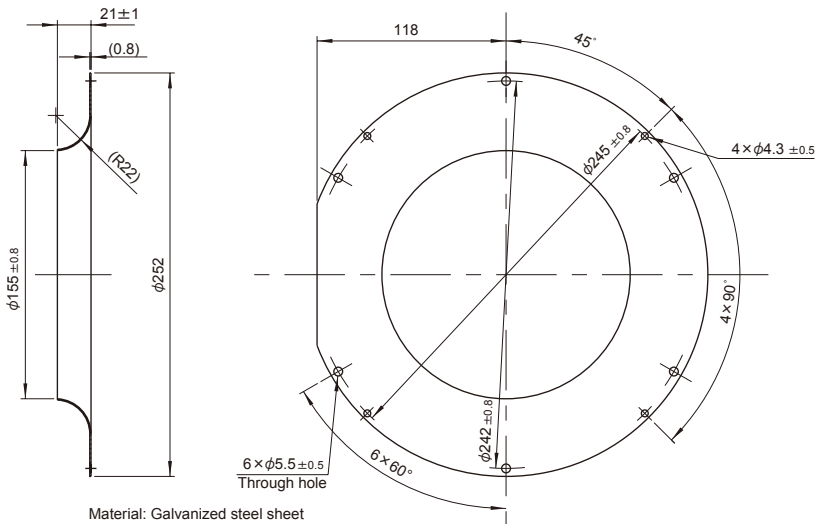

Component (Model Code)	Mating Model Code
<b>E2271 Inlet ring</b>	E2271Z

DC axial fans & blowers with sensors

The DC fans and blowers of our company have a function to send an alarm signal when the fan motor revolutions slow down. Several systems are used to cut off the system power supply by this alarm signal, with three types of sensors available. Select the right type of sensor in accordance with the purpose of use. The lead wire for the sensor is yellow. The output type is an open collector output for all three types.

■ Sensor type

1. Lock detection type (Product code: S)

The output signal indicates an [L] state (transistor is ON) while the propeller is rotating, changing to an [H] state (transistor is OFF) less than five seconds after the propeller stops rotating. The propeller automatically restarts operation within five seconds when the lock is unlocked. ([H] → [L] 5 s). If the pull-up voltage is live, the [H] state (transistor is OFF) will engage in less than five seconds, even when the power is turned off.

- Specification:  $V_{CE} = 28\text{ V max}$  (55.2 V max for 48 V products)  
 $I_C = 5\text{ mA max}$   
( $V_{CE(SAT)} = 0.4\text{ V max}$ )
- Output waveform

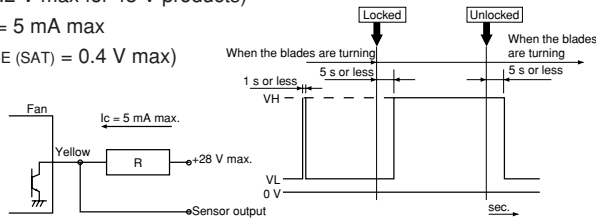

※When the power is turned on, the state sometimes becomes high [H] for several hundred ms.

2. Pulse output type (Product code: P)

A rectangular wave of two pulses will be output for each turn of the propeller while the propeller is rotating, outputting two types of signal depending on the propeller position when the propeller is locked. (See the note below ※)

- Specification:  $V_{CE} = 28\text{ V max}$  (55.2 V max for 48 V products)  
 $I_C = 5\text{ mA max}$   
( $V_{CE(SAT)} = 0.4\text{ V max}$ )
- Output waveform

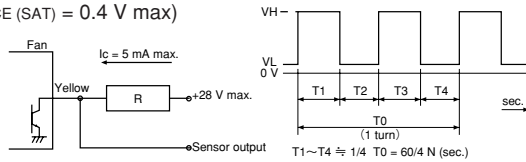

※Output signal waveform when the fan is stopped: The following two types of waveform are output, depending on the blade position when the propeller is stopped:  
Pulse outputs of High - constant or restart timing (0.05 Hz to 2 Hz).

3. Speed detection type (Product code: Q)

The output signal indicates the [H] state when the propeller revolutions are slower than the preset speed, changing to the [L] state when the propeller revolutions exceed the reset speed.

[Products with a reversed output waveform are also available, suitable for a wired OR connection when several fans are installed. Contact us for further information. {Former code: SQ, new code (15 - digit code products): R} ]

- Specification:  $V_{CE} = 28\text{ V max}$  (55.2 V max for 48 V products)  
 $I_C = 5\text{ mA max}$   
( $V_{CE(SAT)} = 0.4\text{ V max at } 5\text{ mA}$ )

● Output waveform

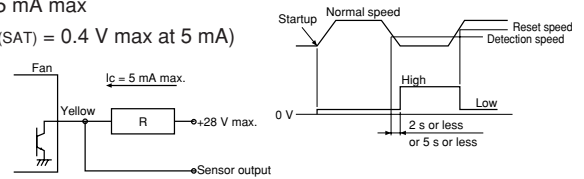

Note: The output waveform for type SQ (R) will be reversed. The speed setting for the alarm output is about half the rated speed. For more detailed information, please request a product delivery specification from us.