

Super Silent Blowers
E1331K

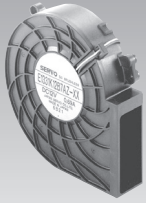

126 × 127 × 31
(5.0" × 5.0" × 1.2")
Max. airflow: 1.08 m³/min
Max. static pressure: 480 Pa
Mass: 250 g

Fan model code

E1331K12B5AZ-00

E1331K12B6AP-00

E1331K12B7AZ-00

E1331K24B7AZ-00

Standard specification

Max. Airflow m ³ /min	CFM	Max. Static Pressure		Noise dB	Speed min ⁻¹	Voltage Spec. V		Current mA		Model Code	Operating Temp. Range °C
		Pa	inH ₂ O			Rating	Operating Range	Rating	Starting		
0.87	31	310	1.25	49	2700	12	6-13.2	690	1790	E1331K12B7AZ-00	-20 ~ +70
						24	12-26.4	380	930	E1331K24B7AZ-00	
0.79	28	250	1.01	47	2500	24	12-26.4	280	710	E1331K24B6AZ-00	
0.72	25	210	0.84	45	2200	12	6-13.2	440	1008	E1331K12B5AZ-00	

- Figures in the table are average measured values. Please request the product delivery specification when preparing a purchase specification.
- The characteristics are the values at rated voltage (12 V or 24 V), and normal temperature and humidity.

General specification

Materials Used	Venturi: ABS and PBT synthetic resins Impeller: ABS and PBT synthetic resins Bearing: Both side shielded ball bearing
Motor	Brushless DC motor, Protection type: Current shut off by detecting lock state, automatically reset
Common Elec. Spec.	See pages G-11, G-12, G-13.

Standard airflow and static pressure characteristics (At rated voltage)

[By double chamber method]

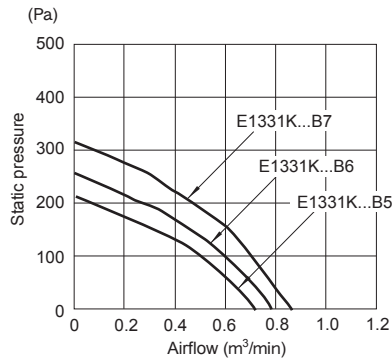

External dimensions in mm (inches)

● Lead wire type

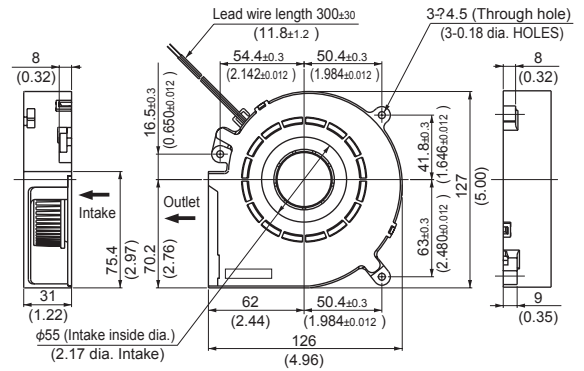

Wiring connection diagram

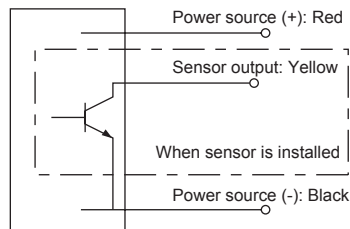

Super silent blower with sensor

Rated Vol.	Model Code
24 V	E1331K24B6AP-00

- Our company can meet many of your requirements for customization, such as special connectors, other sensors not listed above, variable speed specifications, and other modifications. Please contact us during your product planning and development stage.
- The listed products are registered in the following overseas standards files, UL/cUL: E48889, TUV: R50004410

DC axial fans & blowers with sensors

The DC fans and blowers of our company have a function to send an alarm signal when the fan motor revolutions slow down. Several systems are used to cut off the system power supply by this alarm signal, with three types of sensors available. Select the right type of sensor in accordance with the purpose of use. The lead wire for the sensor is yellow. The output type is an open collector output for all three types.

■ Sensor type

1. Lock detection type (Product code: S)

The output signal indicates an [L] state (transistor is ON) while the propeller is rotating, changing to an [H] state (transistor is OFF) less than five seconds after the propeller stops rotating. The propeller automatically restarts operation within five seconds when the lock is unlocked. ([H] → [L] 5 s). If the pull-up voltage is live, the [H] state (transistor is OFF) will engage in less than five seconds, even when the power is turned off.

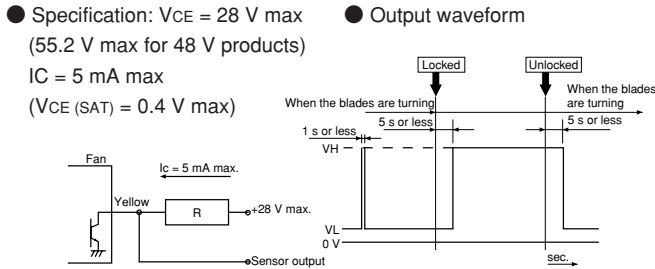

※When the power is turned on, the state sometimes becomes high [H] for several hundred ms.

2. Pulse output type (Product code: P)

A rectangular wave of two pulses will be output for each turn of the propeller while the propeller is rotating, outputting two types of signal depending on the propeller position when the propeller is locked. (See the note below ※)

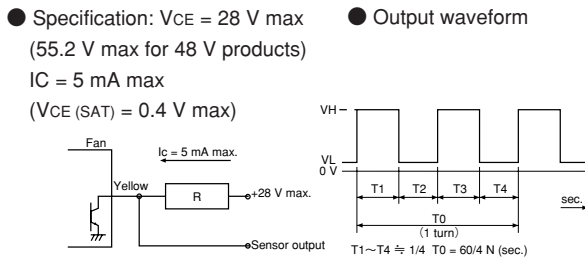

※Output signal waveform when the fan is stopped: The following two types of waveform are output, depending on the blade position when the propeller is stopped:
 Pulse outputs of High - constant or restart timing (0.05 Hz to 2 Hz).

3. Speed detection type (Product code: Q)

The output signal indicates the [H] state when the propeller revolutions are slower than the preset speed, changing to the [L] state when the propeller revolutions exceed the reset speed.

[Products with a reversed output waveform are also available, suitable for a wired OR connection when several fans are installed. Contact us for further information. {Former code: SQ, new code (15 - digit code products): R}]

- Specification: $V_{CE} = 28\text{ V max}$ (55.2 V max for 48 V products)
 $I_C = 5\text{ mA max}$
 $(V_{CE(SAT)} = 0.4\text{ V max at } 5\text{ mA})$

● Output waveform

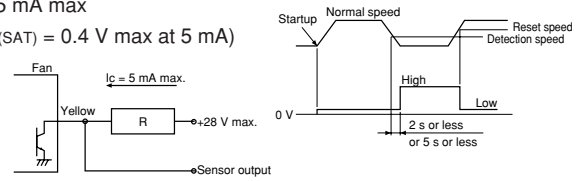

Note: The output waveform for type SQ (R) will be reversed. The speed setting for the alarm output is about half the rated speed. For more detailed information, please request a product delivery specification from us.

AC fans with sensors

By equipping the motor with a rotation detection function, the AC fans of our company have a system to send an alarm signal when the fan motor revolutions slow down and to cut off the system power supply. In 1980, our company developed a system to output an alarm signal by detecting the lowering of generated voltage by installing a tachometer generator with the cooling fan and this system has since been incorporated in our company products. The output type of the alarm signal is an open collector output.

Type	Tachometer generator type			
Sensor output operation	Open collector transistor, permissible sync Current: 50 mA max. Permissible imposed voltage: DC 40 V max. Permissible power consumption: 1.5 W max. (at 25 °C)			
Sensor output operation	AC power supply	Speed	Output transistor operation	Output state
	OFF		OPEN	HIGH (Abnormal)
	ON	Below detection speed	OPEN	HIGH (Abnormal)
	ON	Above detection speed	CLOSE	LOW (Normal)
Detection speed RD	1500 ~ 2200 rpm			
Detection delay time TD	2 s or less 17 Type			
Type	Standard speed			
Insulation resistance	10 M Ω or higher by a DC 500 V: Between the sensor lead and venturi			
Dielectric strength	Between the sensor lead and venturi	No anomaly allowed after applying AC 500 V 50 Hz for 1 minute		

■ Sensor specification

■ Operational and handling precautions

Operate fans and blowers at an ambient temperature of between -10 °C and 60 °C and relative humidity of less than 90 %. Latch output is not used so malfunction by electrical noise can be ruled out. However, note that the semiconductor devices in the internal circuitry may be damaged by electrical noise and high voltage. No delay circuit is provided so a trouble signal is output on startup. As when operating and handling the fan, exercise caution to avoid dropping and exposing the blower to shock and vibration.

■ Sensor connection



1. LED Display

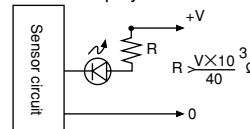

2. Relay operation

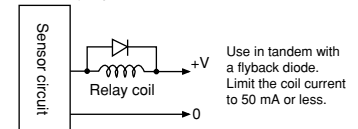

※ A sensor is available with the AS ad PL series only.