

DC Centrifugal  
Blowers  
**E0515H**

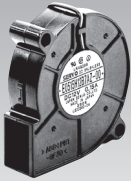

51×53×15  
(2.0"×2.1"×0.6")  
Max. airflow: 0.125 m<sup>3</sup>/min  
Max. static pressure: 210 Pa  
Mass: 30 g

Fan model code

**E0515H12B7AZA01**

**E0515H12B7APA01**

**E0515H12B8AZA01**

**E0515H24B5AZ-00**

**E0515H24B7AZA01**

**E0515H24B8AZA01**

**E0515H24B8ASA01**

Standard specification

Max. Airflow		Max. Static Pressure		Noise	Speed	Input	Voltage Spec. V		Current mA		Model Code	Operating Temp. Range °C
m <sup>3</sup> /min	CFM	Pa	inH <sub>2</sub> O	dB	min <sup>-1</sup>	W	Rating	Operating Range	Rating	Starting		
0.125	4.4	210	0.84	42	6100	2.3	12	6-13.8	190	320	E0515H12B8AZA01	-20 ~ +60
						2.4	24	12-27.6	100	160	E0515H24B8AZA01	
0.11	3.9	165	0.66	40	5500	1.7	12	6-13.8	140	225	E0515H12B7AZA01	-20 ~ +80
						1.9	24	12-27.6	80	130	E0515H24B7AZA01	
0.1	3.5	135	0.54	37	5000	1.4	24	16.8-27.6	60	110	E0515H24B5AZ-00	-20 ~ +60

- Figures in the table are average measured values. Please request the product delivery specification when preparing a purchase specification.
- The characteristics are the values at rated voltage (12 V or 24 V), and normal temperature and humidity.
- The life expectancy of E0515H series products at rated voltage and in continuous operation is 30,000 hours at 60°C.(8 speed except)

General specification

Materials Used	Venturi: ABS and PBT synthetic resins Impeller: ABS and PBT synthetic resins Bearing: Both side shielded ball bearing
Motor	Brushless DC motor, Protection type: Current shut off by detecting lock state, automatically reset
Common Elec. Spec.	See pages G-11, G-12, G-13.

Standard airflow and static pressure characteristics (At rated voltage)

[By double chamber method]

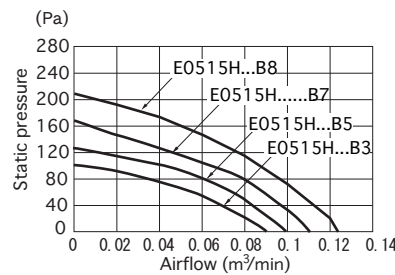

External dimensions in mm (inches)

- Lead wire type

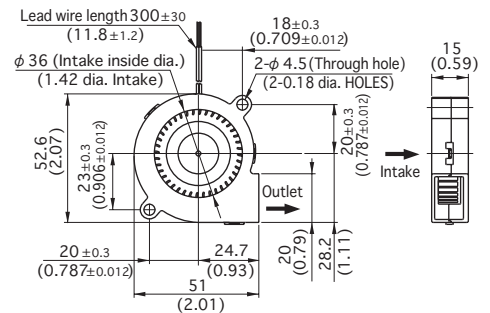

Lead wire spec. UL1061 AWG26 or UL3265 AWG26  
Color (+) Red  
(-) Black

Wiring connection diagram

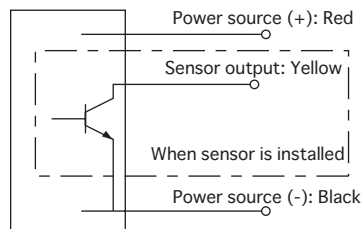

DC centrifugal blower with sensor

Rated Vol.	Model Code	
12 V	<b>E0515H12B7APA01</b>	
24 V	<b>E0515H24B7APA01</b>	<b>E0515H24B8ASA01</b>

- Our company can meet many of your requirements for customization, such as special connectors, other sensors not listed above and other modifications. Please contact our company during your product planning and development stage.
- The listed products are registered in the following overseas standards files, UL: E48889, CSA: LR49399, TUV: R9451586
- 3D data is also available at our web2-CAD site ([www.cadenas.co.jp](http://www.cadenas.co.jp)).

DC axial fans & blowers with sensors

The DC fans and blowers of our company have a function to send an alarm signal when the fan motor revolutions slow down. Several systems are used to cut off the system power supply by this alarm signal, with three types of sensors available. Select the right type of sensor in accordance with the purpose of use. The lead wire for the sensor is yellow. The output type is an open collector output for all three types.

■ Sensor type

1. Lock detection type (Product code: S)

The output signal indicates an [L] state (transistor is ON) while the propeller is rotating, changing to an [H] state (transistor is OFF) less than five seconds after the propeller stops rotating. The propeller automatically restarts operation within five seconds when the lock is unlocked. ([H] → [L] 5 s). If the pull-up voltage is live, the [H] state (transistor is OFF) will engage in less than five seconds, even when the power is turned off.

- Specification:  $V_{CE} = 28\text{ V max}$  (55.2 V max for 48 V products)
- Output waveform
- $I_C = 5\text{ mA max}$
- ( $V_{CE(SAT)} = 0.4\text{ V max}$ )

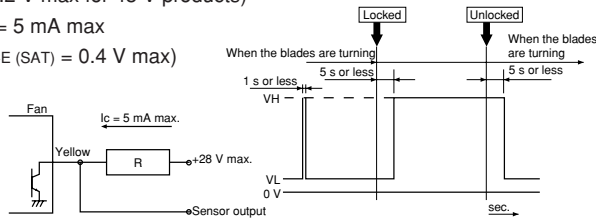

※When the power is turned on, the state sometimes becomes high [H] for several hundred ms.

2. Pulse output type (Product code: P)

A rectangular wave of two pulses will be output for each turn of the propeller while the propeller is rotating, outputting two types of signal depending on the propeller position when the propeller is locked. (See the note below ※)

- Specification:  $V_{CE} = 28\text{ V max}$  (55.2 V max for 48 V products)
- Output waveform
- $I_C = 5\text{ mA max}$
- ( $V_{CE(SAT)} = 0.4\text{ V max}$ )

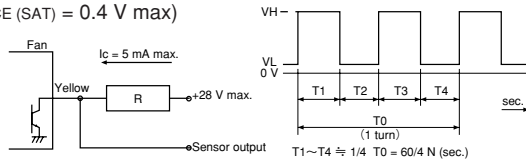

※Output signal waveform when the fan is stopped: The following two types of waveform are output, depending on the blade position when the propeller is stopped:  
Pulse outputs of High - constant or restart timing (0.05 Hz to 2 Hz).

3. Speed detection type (Product code: Q)

The output signal indicates the [H] state when the propeller revolutions are slower than the preset speed, changing to the [L] state when the propeller revolutions exceed the reset speed.

[Products with a reversed output waveform are also available, suitable for a wired OR connection when several fans are installed. Contact us for further information. {Former code: SQ, new code (15 - digit code products): R} ]

- Specification:  $V_{CE} = 28\text{ V max}$  (55.2 V max for 48 V products)
- Output waveform
- $I_C = 5\text{ mA max}$
- ( $V_{CE(SAT)} = 0.4\text{ V max at } 5\text{ mA}$ )

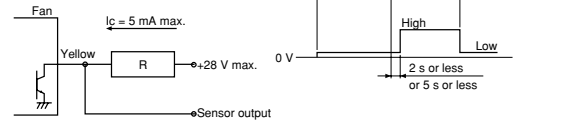

Note: The output waveform for type SQ (R) will be reversed. The speed setting for the alarm output is about half the rated speed. For more detailed information, please request a product delivery specification from us.